

WR5

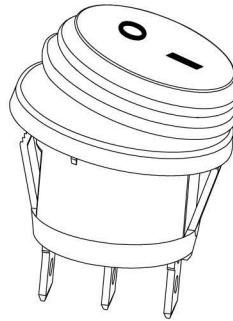

Rating: 12A 125V AC(UL CUL) ;
 10A 250V AC(ENEC CQC) ;
 Contact Resistance: 20mΩ Max. ;
 Insulation Resistance:DC 500V 100MΩ Min. ;
 Dielectric Strength:AC 1500V 1 minute
 Operating Force:350±150gf
 Mechanical Life:50,000 cycles
 Load Life:10,000 cycles
 Operating Temperature: 0 °C~85°C

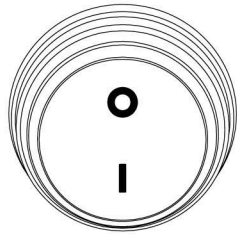
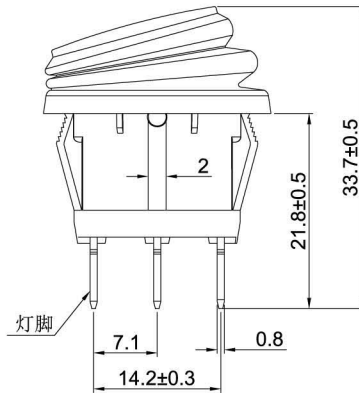
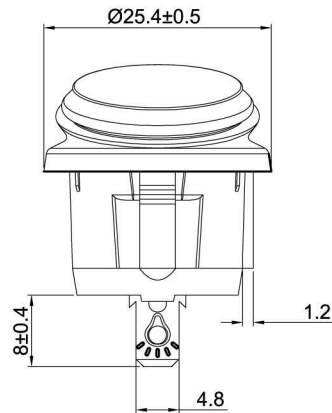

CUT-OUT

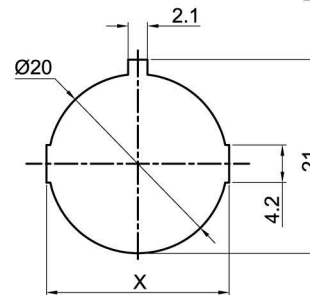

	X
0.75~1.25	20.2
1.25~2.00	20.4
2.00~3.00	20.6

WR5-110-P5L-BR-24
 01.086.0134

MATERIAL:

Body:Nylon66,UL rated:94V-2 min
 Actuator:Nylon66,UL rated:94V-2 min
 Terminal:Brass,silver or tin plated

